

BASE

CUSTOM MADE AWNINGS  
2025 PRODUCT GUIDE



# CONTENTS

## AWNINGS

Base Plus	6
Base Light	8
Epica	10
Epica Lite	12
Armony Plus	14
Arezzo	15
Calnova	18
Zenith	20
Italia Slim	22
Base Traditional	24

## OTHER PRODUCTS

Canopies	28
Motorisation	30
Lighting and Heating	32
Brackets and Supports	34
Designer Fabrics	36



## SECTION 1

# AWNINGS

Our Folding Arm Retractable Awnings offer the best in open-plan outdoor living. We offer solutions for small terraces to large outdoor entertaining areas.

Plus our commercial awnings can be fully customised, to suit the needs of business from retail to hospitality.

---

## CUSTOM MADE IN THE UK

We supply bespoke awnings made to the exact specifications and high quality that our customers require.

We have a close association with BAT who, for over 35 years, have been designing and manufacturing systems and components for cassette awnings and pergolas.

BASE

# AWNINGS

## BASE PLUS

Fully cassetted folding arm awning

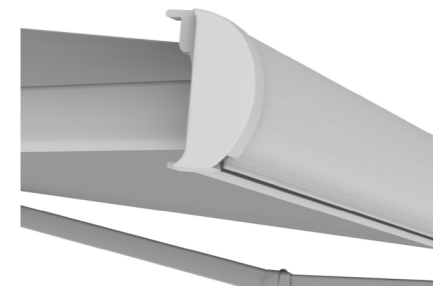
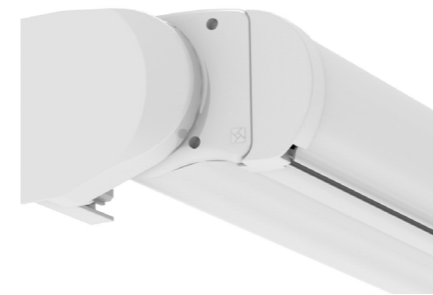
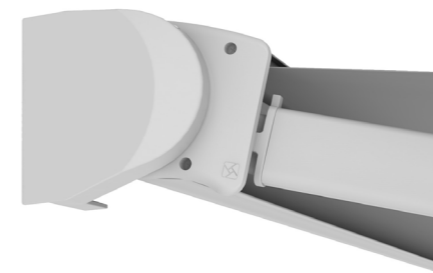
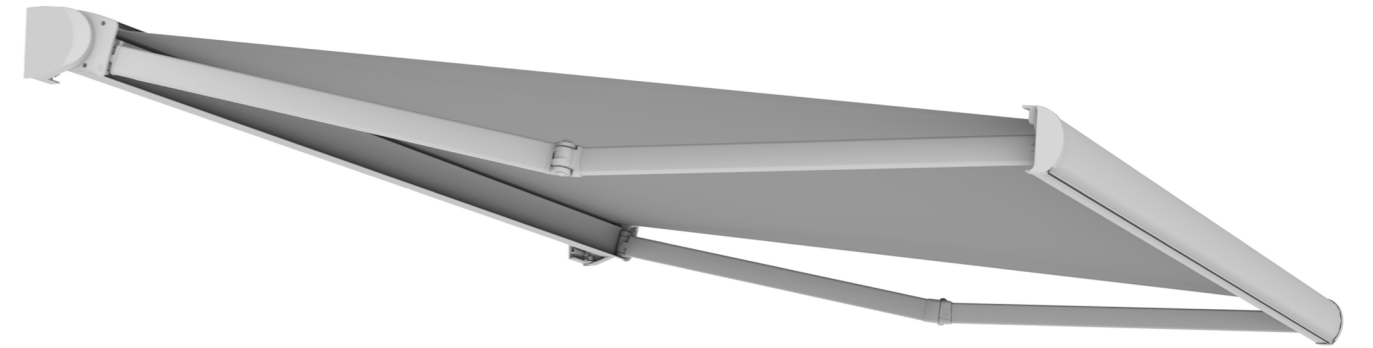
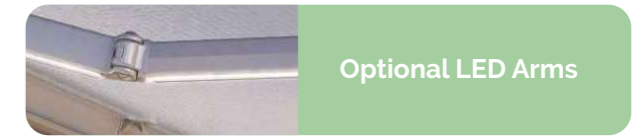

**THE BASE PLUS is a fully cassetted folding arm awning on two brackets fitted at (cm) either end top of face fixed.**

Our most popular awning, operated manually or motorised, is suitable for both domestic and commercial applications. It features a stainless steel chain link arm in four different sizes with or without adjustable ambient LED lighting to suit your wall installation application needs.

Supplied fully set up for a quick and easy installation the innovative design is equipped with an inclination system that uses a pass-through screw to adjust the pitch to your exact needs.

### Installation

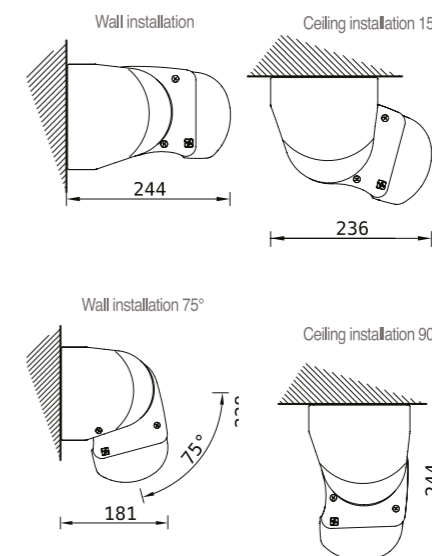

### RAL Colours

- 9010 White (Standard)
- 7016 Textured Anthracite
- 9005 Black

### Min / Max Width

- Minimum 1910mm
- Maximum 6000mm

### Minimum width to accommodate arm size

Projection (cm)	Width (cm) 2 brackets
160	191
210	241
260	291
310	341



AWNINGS

# BASE LITE

Fully cassetted folding arm awning

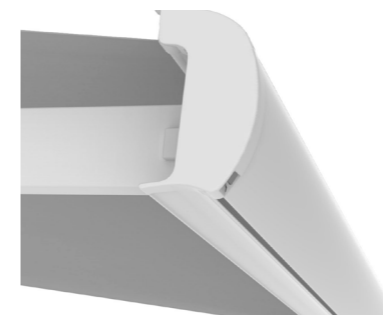
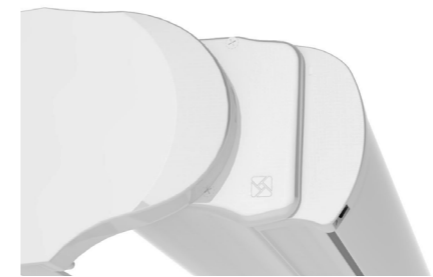
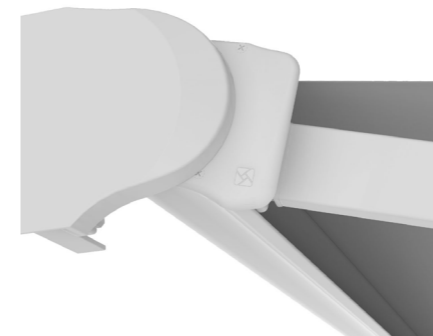
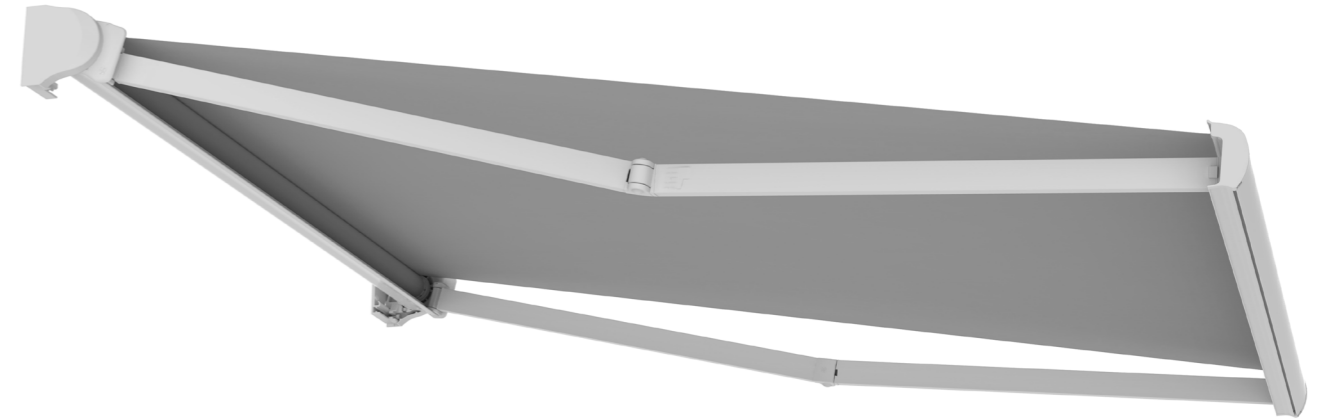

**BASE LITE** as the name suggests is a core part of the **Base Family**, built to replicate the base plus but in **smaller proportions**.

This Fully cassetted system is a fantastic addition to any property, whether extending the home with a welcome shaded area to your garden patio or protecting your shop window from light showers or a dazzling sunshine glare.

Due to its tight and compact finish the base plus accommodates a width up to 4m with three different projections in arm length.

Available top or face fixed with a bracket at either end a quick and easy install is easy to achieve with a simple adjustment to the pitch with a screw in system.

### Installation

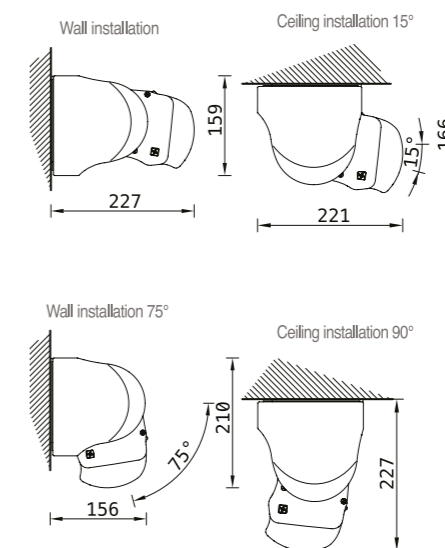

### RAL Colours

9010 White (Standard)

### Min / Max Width

Minimum 1910mm  
Maximum 4000mm

### Minimum width to accommodate arm size

Projection (cm)	Width (cm) 2 brackets
160	191
210	241
260	291



AWNINGS

# EPICA

Fully cassetted folding arm awning on two side brackets



Optional LED Arms

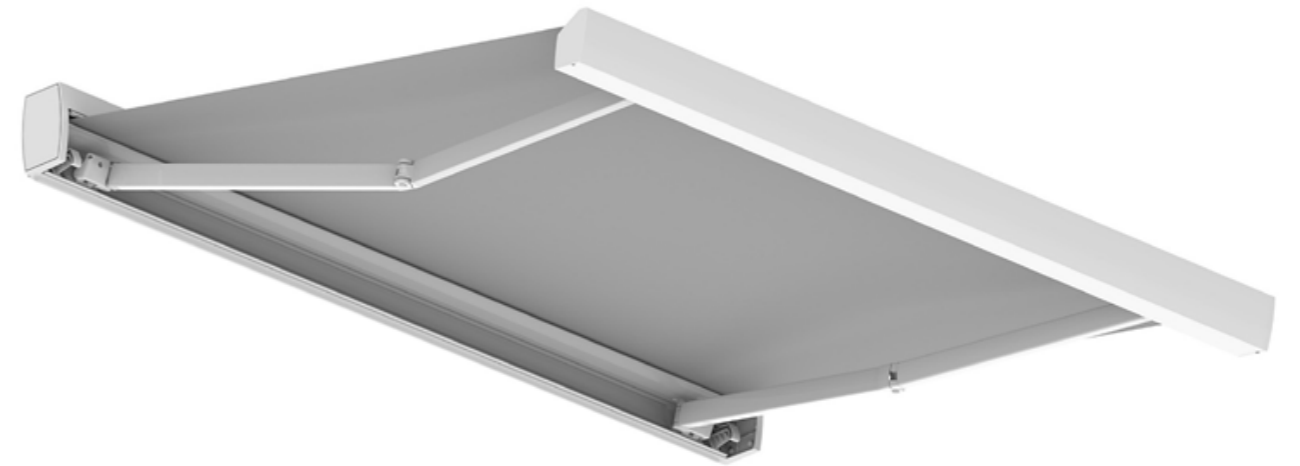

**EPICA is one of our top models: a full cassette awning, particularly eye-catching thanks to its harmonious shape and integrated LED lighting across the cassette box, creating a spectacular effect across the outer silhouette.**

It features hidden fixings, adjustable brackets, and a patented tipping system for perfect front bar closure. A drop valance can be added for further shading control. The Epica when joined can span a width of 12 metres. Optional extras include integrated lighting and a box front bar for added style and function plate either a wall or a ceiling installation.

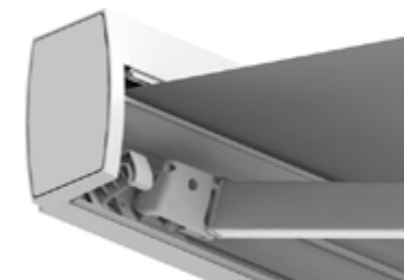
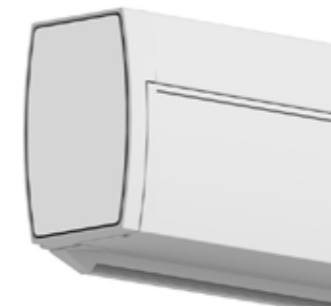
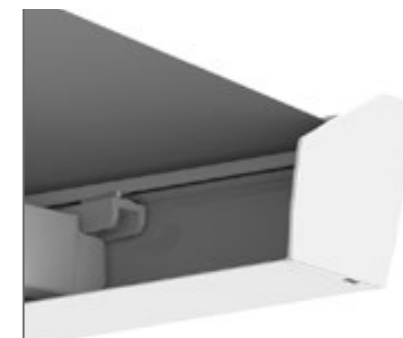

**Installation**

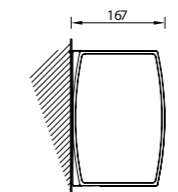

Wall installation

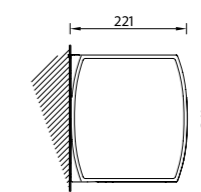

Wall installation with box front bar

**RAL Colours**

7016 Textured Anthracite

**Min / Max Width**

Minimum 2210mm  
Maximum 12000mm

**Minimum width to accommodate arm size**

Projection (cm)	Width (cm) 2 brackets
160	221
210	271
260	321
310	371
360	424 Giant
410	472 Giant





AWNINGS  
**EPICA LITE**

Fully cassetted compact folding arm awning



**Full cassette folding arm awning on two end fix brackets complete with our signature Balteus arms with or without LED lights.**

A sleek full cassette folding arm awning with a compact design, the Epica Lite offers up to 410cm projection using Giant arms. Suitable for wall or ceiling installation, it features hidden fixings, adjustable brackets, and a patented tipping system for perfect front bar closure. Optional extras include integrated lighting and a box front bar for added style and function.

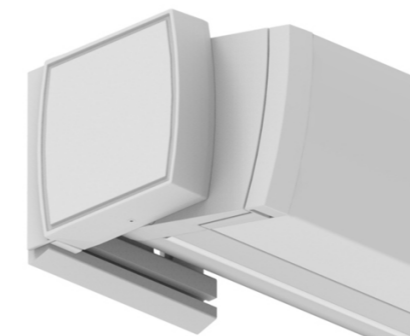

**Installation**

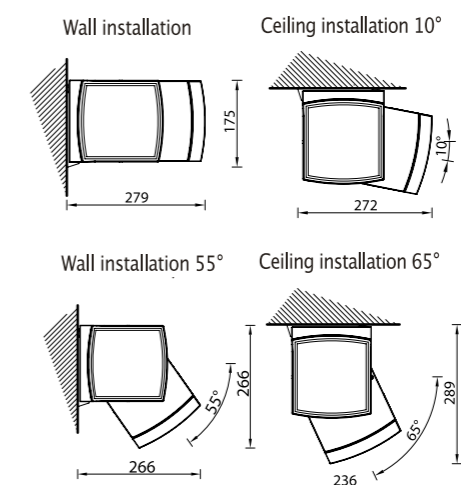

**RAL Colours**

- 9010 White (Standard)
- 7016 Anthracite
- 9005 Black

**Min / Max Width**

- Minimum 2130mm
- Maximum 6000mm

**Minimum width to accommodate arm size**

Projection (cm)	Width (cm) ≥ brackets
160	213
210	263
260	313
310	363
360	413
410	463





Optional LED Arms

AWNINGS

# ARMONY PLUS

Fully cassetted folding arm awning



**THE ARMONY PLUS** incorporates design and style into a fully cassetted system, whilst retaining its strength through an impressive and innovative multi bracket fixing system along the length of the Awning.

This system lends itself to larger applications, supplied up to 7M in one length and a massive 12m with a seamless profile join for an on-site build up. Not only does this Awning accommodate large widths, but a more than impressive 5 projections up to 3.6m with or without incorporated LED lights.

This carefully put together combination of design features makes it our most popular system for Commercial applications along with large domestic applications.



**Installation**

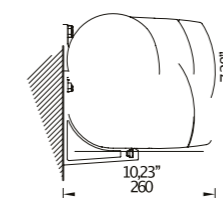

Wall installation

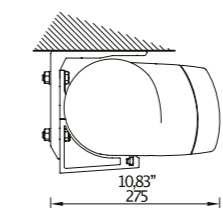

Ceiling installation

**RAL Colours**

- 9010 White (Standard)
- 7016 Anthracite
- 9005 Black

**Min / Max Width**

- Minimum 2120mm
- Maximum 12000mm

**Minimum width to accommodate arm size**

Projection (cm)	Width (cm) 2 brackets
160	212
210	262
260	312
310	372
360	431



AWNINGS

# AREZZO

A compact folding arm awning on 40mm zinc plated and painted square bar.



**THE AREZZO is a compact folding arm awning on 40mm zinc plated and painted square bar, double cables or stainless chain arms with extruded aluminium arm bracket.**

An extruded aluminium hood and a special bracket for under-roof mounting is available optionally.

**Installation**

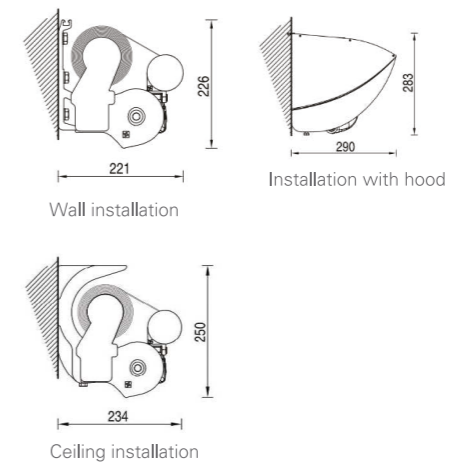

**RAL Colours**

- 9010 White (Standard)
- 7016 Anthracite
- 9005 Black

**Min / Max Width**

- Minimum 2070mm
- Maximum 12000mm

**Minimum width to accommodate arm size**

Projection (cm)	Width (cm) 2 brackets
160	207
210	257
260	307
310	357
360	407
410	457



# AWNINGS

## CALNOVA

Semi cassetted folding arm awning



As our newest addition we are excited to introduce the **CALNOVA** to our range of products.

Calnova boasts a steel square back bar system providing a strong and flexibility fitting method either top or face fix.

The Semi Cassetted design accommodates the fabric for protection all year round when retracted, whilst the patented tipping system allows adjustment to the Awning pitch when extend out to one of its 5 available projections.

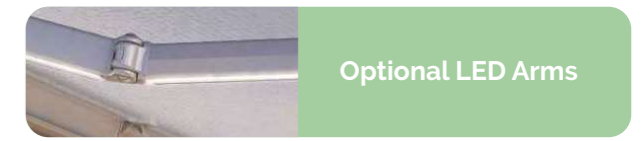

### Installation

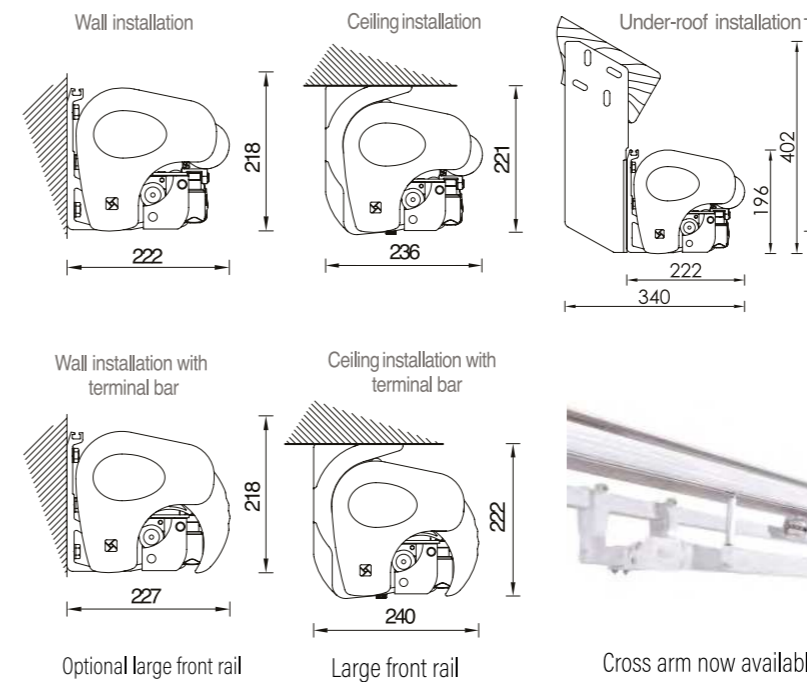

### RAL Colours

- 9010 White (Standard)
- 7016 Anthracite
- 9005 Black

### Min / Max Width

- Minimum 2100mm
- Maximum 12000mm

### Minimum width to accommodate arm size

Projection (cm)	Width (cm) 2 brackets
160	210
210	260
260	310
310	360
360	410



AWNINGS

# ZENITH

Fully cassetted folding arm awning



ZENITH is a retractable awning with a fully closing cassette on a rectangular bar 50x30mm. Functional and reliable this awning gets tipping system (BAT patented) brackets that enables a complete perfect closing of the front bar even at maximum inclinations.



**Installation**

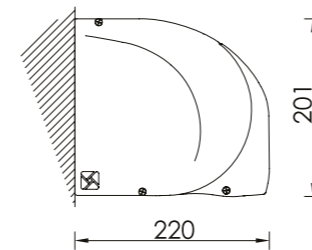

Ceiling installation

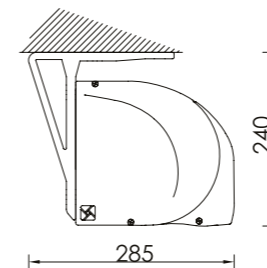

**RAL Colours**

9010 White (Standard)

**Min / Max Width**

Minimum 2220mm  
Maximum 12000mm

**Minimum width to accommodate arm size**

Projection (cm)	Width (cm) 2 brackets
160	210
210	260
260	310
310	360
360	410
410	481
435	506



AWNINGS  
**ITALIA SLIM**  
 Drop arm awning



**The ITALIA SLIM uses spring loaded arms to ease the fabric back into the fully enclosed cassette.**

The operation of the awning is both smooth and effortless.

As the awning closes, the sculptured bottom rail fits snugly into the top cassette box, to form a weather-proof enclosure to protect the fabric.

**RAL Colours**

9010 White (Standard)

**Min / Max Width**

Minimum 1200mm  
 Maximum 4000mm

**Installation**

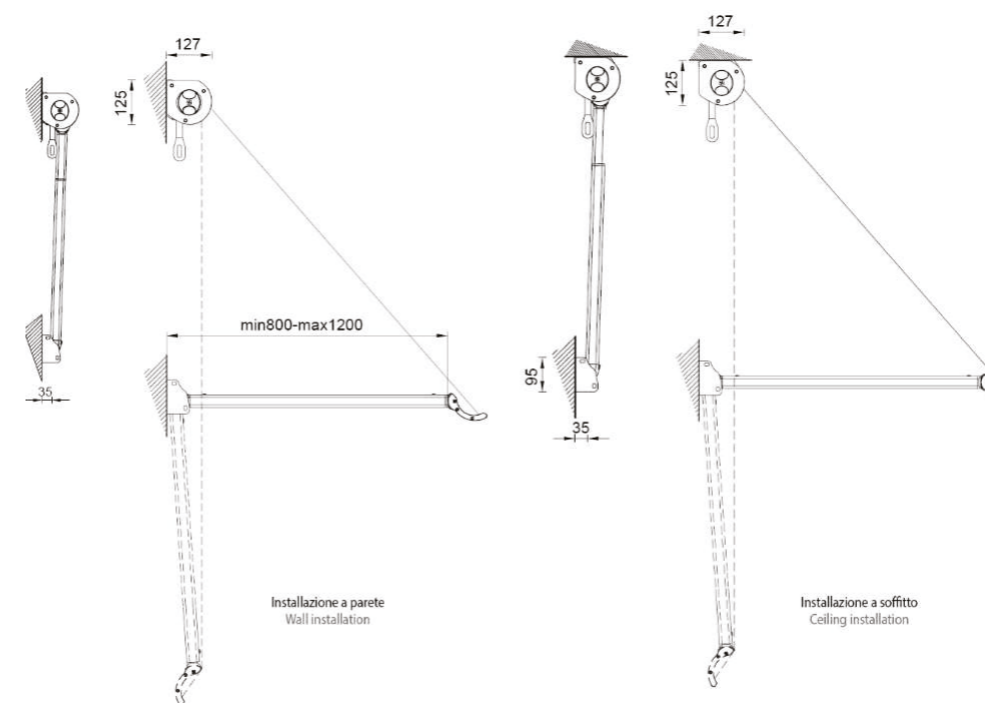

# AWNINGS

## BASE

# TRADITIONAL

Fully cassetted folding arm awning on two side brackets

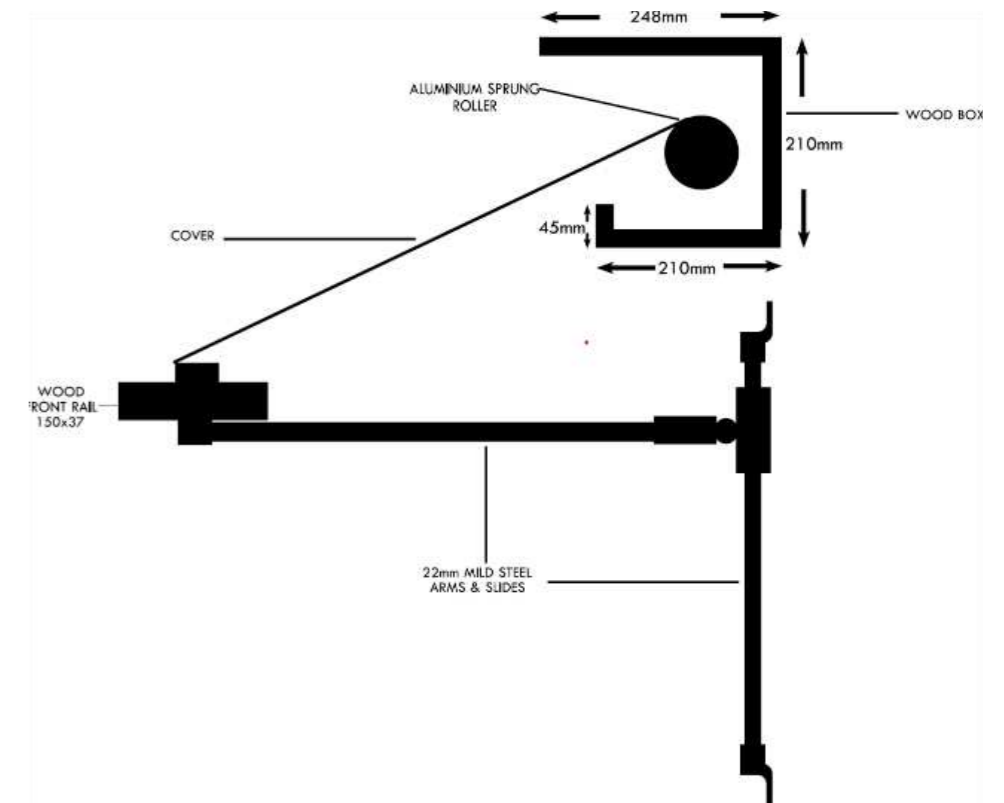

Also known as Victorian Awnings, Traditional Shop Blinds have been a staple of high streets since the Victorian era and remain just as popular today. Combining timeless elegance with practical benefits, these awnings enhance the character of any storefront while providing effective protection against sun and rain.

Handcrafted to suit any application, each awning is custom-made to order, ensuring a perfect fit for your business. A variety of shaped arms are available to complement different architectural styles, adding both functionality and aesthetic appeal. Additionally, awnings can be professionally signwritten, offering an excellent way to showcase your brand and enhance visibility.

Ideal for shops, cafés, and restaurants looking to create a sophisticated, heritage-inspired aesthetic, Traditional Shop Blinds provide a striking combination of style, practicality, and promotional impact.



SECTION 2

# OTHER PRODUCTS

BASE

OTHER PRODUCTS

# CANOPIES

Base manufacture on the premises canopies of various shapes and sizes.

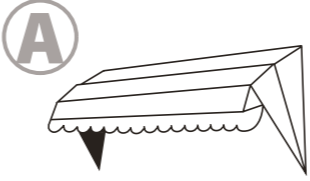
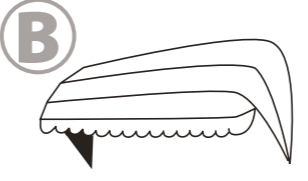
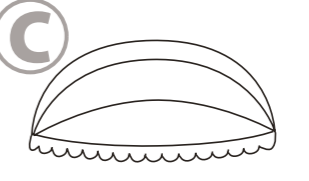
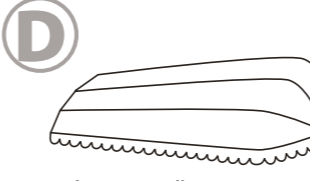
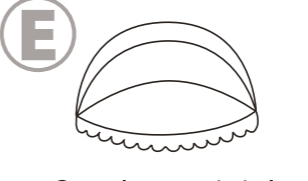
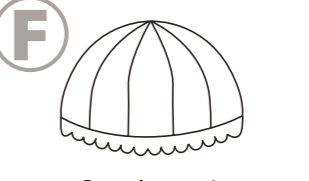
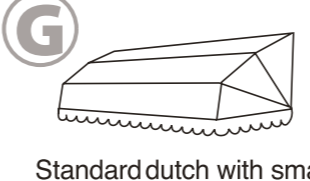
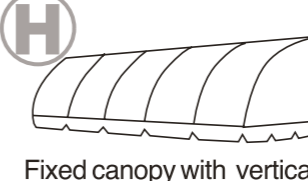
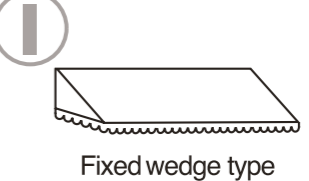
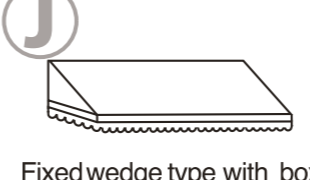
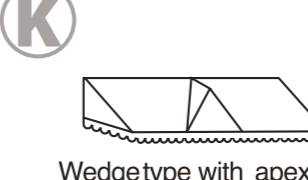
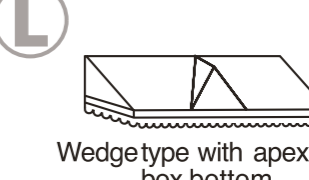
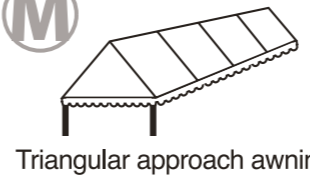
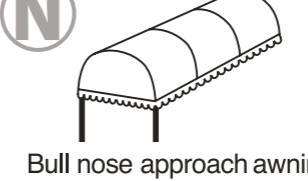
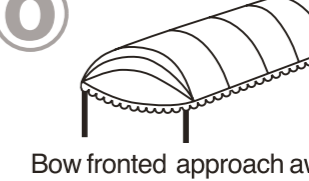

## Canopy and Walkway Styles

<b>A</b>  Small radius corner with short front arm	<b>B</b>  Large radius corner with short front arm	<b>C</b>  Bow blind
<b>D</b>  Large radius corner	<b>E</b>  Complete semi-circle	<b>F</b>  Cupola awning
<b>G</b>  Standard dutch with small radius corner	<b>H</b>  Fixed canopy with vertical hoops	<b>I</b>  Fixed wedge type
<b>J</b>  Fixed wedge type with box bottom	<b>K</b>  Wedge type with apex	<b>L</b>  Wedge type with apex and box bottom
<b>M</b>  Triangular approach awning	<b>N</b>  Bull nose approach awning	<b>O</b>  Bow fronted approach awning

## Specification

### Options

Powder coated frame  
PVC/ wet look fabric

### Standard

Anodised frame  
Dickson Acrylic fabric  
Colour coordinated hidem

Shapes A-G retractable as standard with cord and cleat (can also be supplied fixed)

Shapes H-L fixed.

Maximum width 6M maximum projection 1.5M

Shapes M,N and O walkway structures max width 3M max projection continual with additional supporting legs.

\*Over 5M wide, centre support required.

## Valance Shapes



## Colours

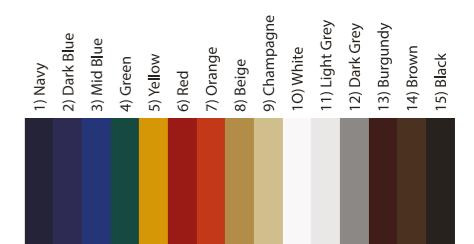

ACCESSORIES

# MOTORISATION

Enjoy your awning with ease

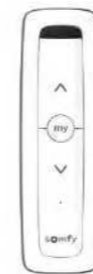

**Situo 1 IO (single channel remote)**



**Situo 5 IO (5 channel remote)**

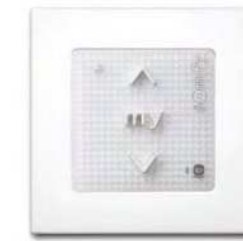

**Smoove IO Wall Mounted Switch**



**Situo Variation Anemometer IO (1 channel remote)**



**Situo Variation Anemometer IO (5 channel remote)**



**Soliris IO Mains Powered, Wireless Sun & Wind Sensor**

Controls sun protections on the basis of the measured amount of sunlight and wind speed up and down.



**Eolis IO Wind Sensor Battery Powered**

Automatically controls awnings upwards based on the measured wind speed.



**Eolis 3D Wirefree IO Anemometer Wind Sensor Battery Powered**



**Eolis 3D Vibration Sensor Battery Powered (White/ Black)**

## Motorisation

Somfy motors makes awnings electrically operable. Their motors are suitable for installation on most available manual awnings, and can also be integrated directly into a new tailor-made sun shade. We have a wide range of motors, each with their specific properties and areas of application.



**Somfy IO Motor**

ACCESSORIES

# LIGHTING AND HEATING

Extend your outdoor entertaining into the evening with LED Lights and Infrared Heaters.



## LIGHTING

Lighting is the missing touch to an awning you never knew you needed.

Awnings designed to provide shelter from the Sun during the day, also create a warm atmospheric environment to sit under in the evening; whether enjoying a drink with friends or a meal with family, our adjustable LED lighting strips incorporated into the arms can also dim to 50% brightness.

### LED lights built into the awning arms



Available on Base Plus and Armony Plus models

### LED lighting receiver



Somfy io-home control



All LED light arms are supplied with an external electrical box to house the receiver and transformer along with a wiring diagram.

**Dimensions:**

230mm wide x 180 deep x 88mm high

## HEATING

The Rio Grande is a fully weatherproof infrared heater used in all seasons, and comes with a safety guard fitted as standard.

This popular weatherproof infrared heater comes with a two year manufacturer's warranty and is a must have for any wholesaler, contractor and distributor wanting to add one of the best infrared heaters available on the market to their range.

Installation of the Rio Grande Single couldn't be easier and comes as standard, with a central 'swivel' bracket that allows you to mount the heater horizontally or at an angle. The Rio Grande Single produces radiant heat just like the sun, directly warming people and objects rather than the air in between.



### Rio Grande Single

- Heat Coverage Area 12m sq.
- Available in any RAL colour
- 1.5kW - 2.0kW
- 2.8kg

### Accessories

A wide selection of switches and heater controls that are suited to almost any situation and need. Where energy and cost savings matter, we don't believe in heating an empty space or having more heat than is required.

Operated through your Somfy Awning remote or combined with a touch/presence timer, our ambient range can be adjusted to ensure energy efficiency whilst ensuring maximum user comfort and energy savings.

### Technical

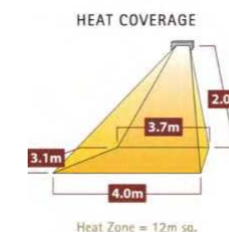
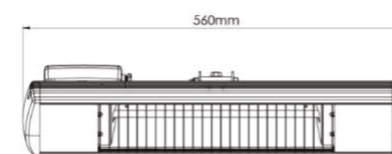

ACCESSORIES

# BRACKETS AND SUPPORTS

At Base, we offer a wide range of bespoke, custom brackets. Below, you'll find some of our most popular bracket solutions. If you have any specific requirements, feel free to contact us.



**Standard Specification:**

Mild steel (stainless steel optional)  
Powder-coated to match your awning

**Spreader Bracket (Plate)**

Standard fixing for single storey extensions and load-bearing applications. Designed to spread the load away from the top of the wall on a single storey extension.

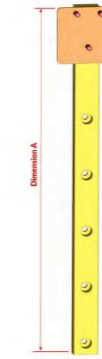

**Gutter Bracket**

The Gutter Bracket is designed to be the perfect solution for low installation heights and to overcome obstructions which can arise when fitting awnings to bungalow roof lines or above outward opening doors where additional height is required.

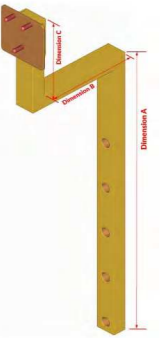

**Pipe Bracket**

Safe and compact Brackets for installing around wastewater pipes, probably the most common obstruction encountered when installing awnings.

The Waste Pipe Bracket is designed to overcome the installation of awnings in front of downpipes or uneven walls. It can also be used where there are limited fixing points below the awning mounting point, i.e. window/door reveal.

The critical dimension always to check, is from the back of the wall to the front of the obstruction. We recommend that the projection or as we like to refer to it, doesn't exceed 300mm.

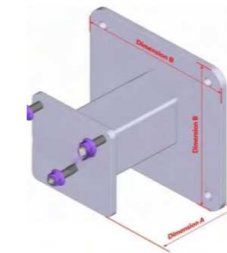

**Spreader Sign Bracket**

The fixing plate encompasses the signpost & can be moved to the correct position by the use of a grub screw which tightens the plate so ensuring a safe and worry-free installation.

The sign can be utilised on either hand & these are attached to the spreader via 2 x M8 x 80 mm fixings.

All dimensions are standard 930 legs with 5 fixings, 400 mm signpost.

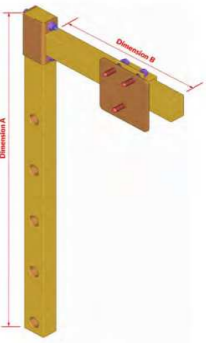

**Spreader Sign Bracket**

The Gutter Sign allows a flexible fixing position away from your installation point. It allows the flexibility of installation in reveals and over patio windows. It is supplied with a movable clamp which you can lock into position so obtaining the correct fixing position as preferred by manufacturers.

When you cannot get near the fixing position wanted 'Gutter Signs' are often the solution to the perfect fix and giving you flexibility, like the gutter bracket the gutter sign is designed to be the perfect solution for low installation heights and to overcome obstructions but also offer adjustability in the horizontal direction.

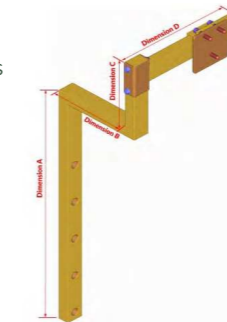

**Double Cranked Bracket**

Double Cranked Gutter Sign Bracket - 90 Degree Corner Only

This bracket is designed to be the perfect solution for low installation heights and to overcome obstructions which can arise when fitting awnings to bungalow roof lines or above outward opening doors where additional height is required.

- Bracket is supplied with a standard front mounted plate.
- Bracket can only be made from 60x60 or bigger box section.

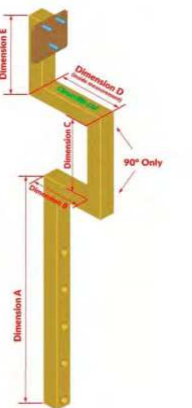

ACCESSORIES

# DESIGNER FABRICS

From Dickson



**Although Dickson awning fabrics are primarily designed to provide effective protection from UV rays and heat, thanks to their unique coating, Dickson fabrics also afford protection against short showers and light rain.**

Additionally, they are able to protect the awnings from the elements by preventing water and dirt penetration. They are the ideal complement to exceptional spaces in cities, the countryside or at sea, they protect from natural hazards such as pollution, stains, sun damage and mold.

Both technically advanced and highly decorative, the fabric collections developed by the Dickson® Design department are in tune with the latest trends.

There is a comprehensive range of styles, colours and textures, you can choose from and whatever your specific wishes and needs, our team will be able to advise you on the most suitable solutions..

View all the fabric available online at  
[www.dickson-constant.com/en/solar-protection.html](http://www.dickson-constant.com/en/solar-protection.html)

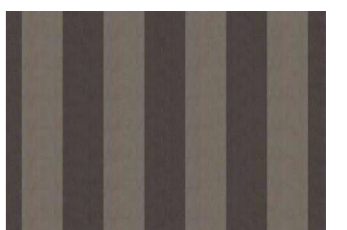
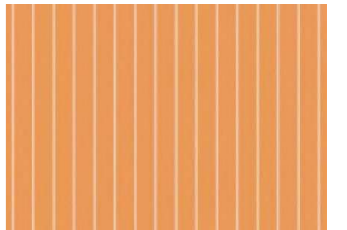

TAILORED FINISHES

# SIGN WRITING & POWDER COATING

Options



At Base Direct, we believe that your awning should do more than just provide shade—it should enhance your brand, complement your property, and stand the test of time. That's why we offer specialist sign writing and powder coating services across our awning range, designed to elevate both commercial and premium residential installations.

### Commercial Sign Writing: Make Your Business Stand Out

Transform your awning into a powerful advertising tool with our professional sign writing service. Ideal for retail, hospitality, and customer-facing premises, our team can apply your branding directly onto the awning fabric or valance in crisp, long-lasting detail.

Perfect for shopfronts, cafés, bars, restaurants, salons, and boutiques

High-resolution logos, text, and brand colours

UV-stable and weather-resistant for lasting visibility

Whether it's a bold logo, a classic shop name, or a refined monogram, we'll help you make the right impression from the moment customers arrive.

### Powder Coating: Colour-Match with Confidence

Give your awning framework a sleek, professional finish with our custom powder coating service. Suitable for both commercial and premium residential applications, powder coating allows you to align the hardware with your brand palette, architectural style, or personal design preferences.

- Full RAL colour range available
- Smooth, durable finish that resists corrosion, chips, and fading
- Perfect for businesses seeking a polished, on-brand appearance
- Adds a design-led finish for high-end homes and contemporary builds

### Design Tip:

For residential spaces, consider a matte bronze, anthracite grey, or textured black to blend beautifully with modern glazing and exterior materials. For commercial premises, branded tones or high-contrast whites and blacks can deliver real impact.





**basedirect.co.uk**

01922 644429  
sales@basedirect.co.uk

Unit 2B Masonry Trading Estate, 135A Bloxwich Road, Wallsall, West Midlands. WS2 8BS